

## PRODUCT FEATURES

- Ultrafast Reverse Recovery Time
- Soft Reverse Recovery Characteristics
- Low Reverse Recovery Loss
- Low Forward Voltage
- High Surge Current Capability
- Low Inductance Package



## APPLICATIONS

- Inversion Welder
- Uninterruptible Power Supply (UPS)
- Plating Power Supply
- Ultrasonic Cleaner and Welder
- Converter & Chopper
- Power Factor Correction (PFC) Circuit

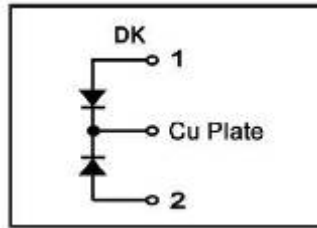

## ABSOLUTE MAXIMUM RATINGS

 $T_C=25^{\circ}\text{C}$  unless otherwise specified

Symbol	Parameter	Test Conditions	Values	Unit
$V_R$	Maximum D.C. Reverse Voltage		400	V
$V_{RRM}$	Maximum Repetitive Reverse Voltage		400	V
$I_{F(AV)}$	Average Forward Current	$T_C=125^{\circ}\text{C}$ , Per Diode	100	A
		$T_C=125^{\circ}\text{C}$ , Per Moudle	200	A
		$T_C=125^{\circ}\text{C}$ , 20KHz, Per Moudle	150	A
$I_{F(RMS)}$	RMS Forward Current	$T_C=125^{\circ}\text{C}$ , Per Diode	150	A
$I_{FSM}$	Non-Repetitive Surge Forward Current	1/2 Cycle , 50Hz, Sine	1500	A
		1/2 Cycle , 60Hz, Sine	1800	A
$I^2t$	$I^2t$ (For Fusing)	$T_J=45^{\circ}\text{C}$ , $t=10\text{ms}$ , 50Hz, Sine	11250	$\text{A}^2\text{s}$
		$T_J=45^{\circ}\text{C}$ , $t=8.3\text{ms}$ , 60Hz, Sine	16200	$\text{A}^2\text{s}$
$P_D$	Power Dissipation		833	W
$T_J$	Junction Temperature		-40 to +150	$^{\circ}\text{C}$
$T_{STG}$	Storage Temperature Range		-40 to +125	$^{\circ}\text{C}$
Torque	Module-to-Sink	Recommended (M6)	3~4.7	N·m
Torque	Module Electrodes	Recommended (M6)	3~4.7	N·m
$R_{\theta JC}$	Thermal Resistance	Junction-to-Case	0.15	$^{\circ}\text{C}/\text{W}$
Weight			92	g

ELECTRICAL CHARACTERISTICS

T<sub>C</sub>=25°C unless otherwise specified

Symbol	Parameter	Test Conditions	Min.	Typ.	Max.	Unit
I <sub>RM</sub>	Reverse Leakage Current	V <sub>R</sub> =400V	--	--	0.5	mA
		V <sub>R</sub> =400V, T <sub>J</sub> =125°C	--	--	1	mA
V <sub>F</sub>	Forward Voltage	I <sub>F</sub> =100A	--	1.1	1.35	V
		I <sub>F</sub> =100A, T <sub>J</sub> =125°C	--	1.0	1.25	V
t <sub>rr</sub>	Reverse Recovery Time	I <sub>F</sub> =1A, V <sub>R</sub> =30V, di <sub>F</sub> /dt=-200A/μs	--	38	--	ns
t <sub>rr</sub>	Reverse Recovery Time	V <sub>R</sub> =200V, I <sub>F</sub> =100A	--	95	--	ns
I <sub>RRM</sub>	Max. Reverse Recovery Current	di <sub>F</sub> /dt=-200A/μs, T <sub>J</sub> =25°C	--	8.5	--	A
t <sub>rr</sub>	Reverse Recovery Time	V <sub>R</sub> =200V, I <sub>F</sub> =100A	--	150	--	ns
I <sub>RRM</sub>	Max. Reverse Recovery Current	di <sub>F</sub> /dt=-200A/μs, T <sub>J</sub> =125°C	--	14	--	A

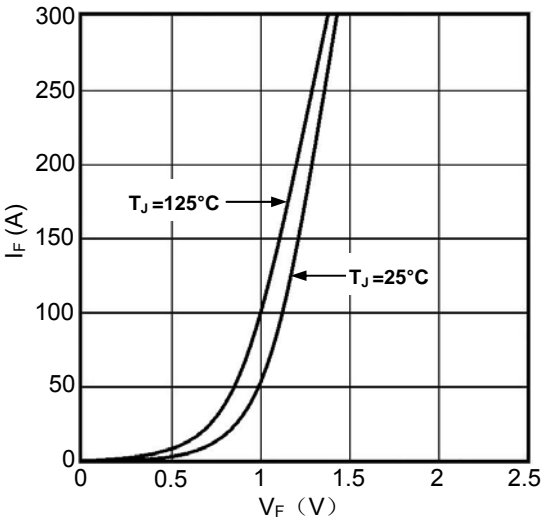

Figure1. Forward Voltage Drop vs Forward Current

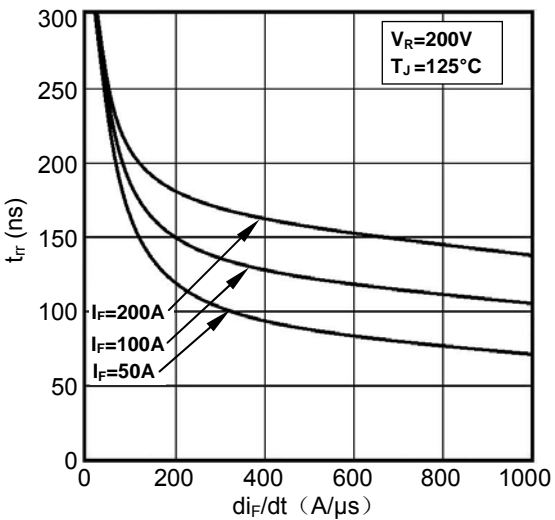

Figure2. Reverse Recovery Time vs di<sub>F</sub>/dt

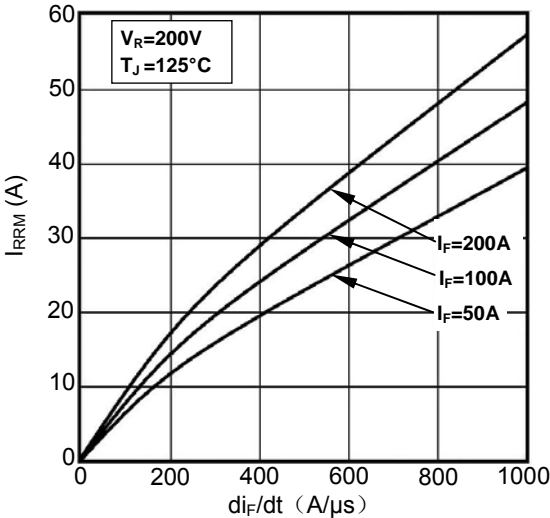

Figure3. Reverse Recovery Current vs di<sub>F</sub>/dt

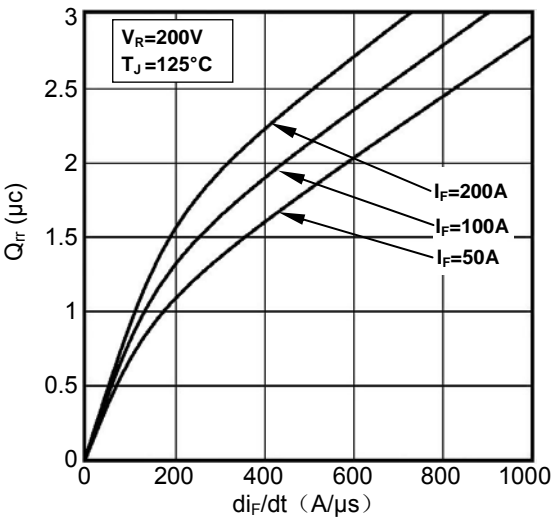

Figure4. Reverse Recovery Charge vs di<sub>F</sub>/dt

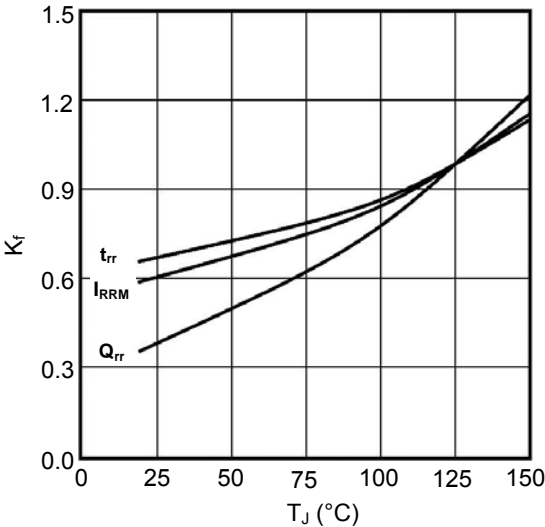

Figure5. Dynamic Parameters vs Junction Temperature

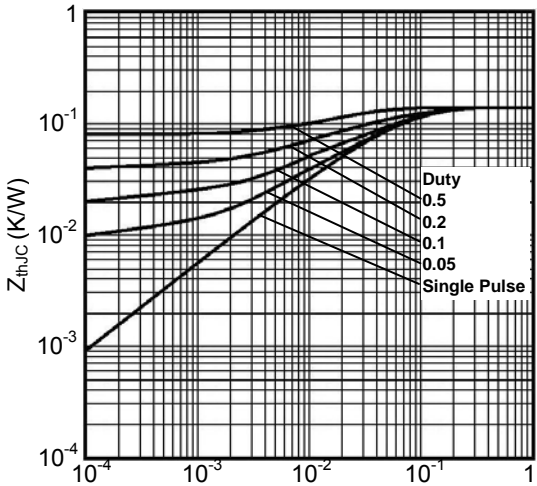
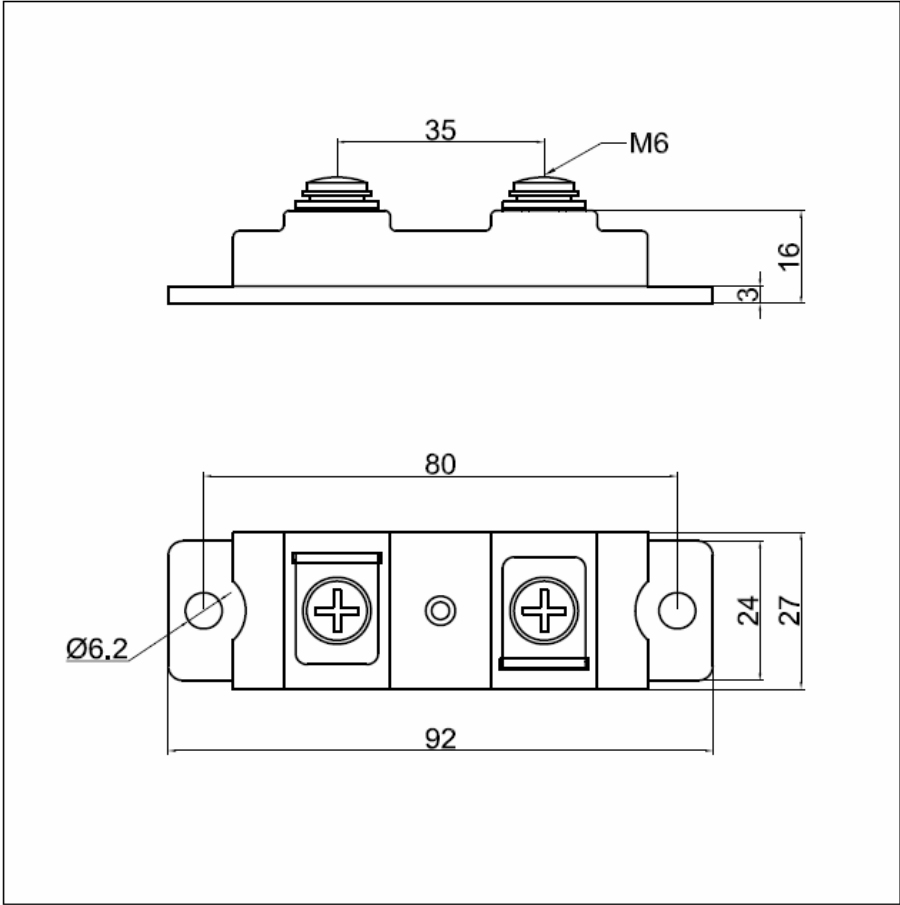

Figure6. Transient Thermal Impedance



Dimensions (mm)  
Figure7. Package Outline