



January 2011

PRELIMINARY

MMF800Y020DK1

200V 800A FRED Module

RoHS Compliant

PRODUCT FEATURES

- Ultrafast Reverse Recovery Time
- Soft Reverse Recovery Characteristics
- Low Reverse Recovery Loss
- Low Forward Voltage
- High Surge Current Capability
- Low Inductance Package

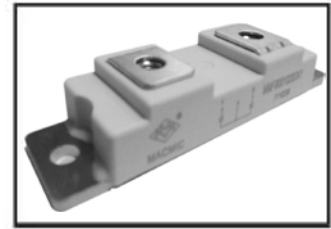

APPLICATIONS

- Inversion Welder
- Uninterruptible Power Supply (UPS)
- Plating Power Supply
- Ultrasonic Cleaner and Welder
- Converter & Chopper
- Power Factor Correction (PFC) Circuit

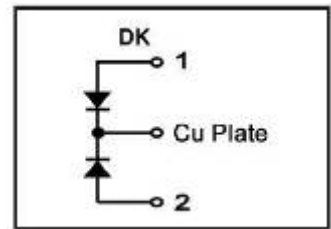

ABSOLUTE MAXIMUM RATINGS

T_C=25°C unless otherwise specified

Symbol	Parameter	Test Conditions	Values	Unit
V _R	Maximum D.C. Reverse Voltage		200	V
V _{RRM}	Maximum Repetitive Reverse Voltage		200	V
I _{F(AV)}	Average Forward Current	T _C =125°C, Per Diode	400	A
		T _C =125°C, Per Moudle	800	A
		T _C =125°C, 20KHz, Per Moudle	560	A
I _{F(RMS)}	RMS Forward Current	T _C =125°C, Per Diode	560	A
I _{FSM}	Non-Repetitive Surge Forward Current	1/2 Cycle , 50Hz, Sine	4000	A
		1/2 Cycle , 60Hz, Sine	4350	A
I ² t	I ² t (For Fusing)	T _J =45°C, t=10ms, 50Hz, Sine	80000	A ² s
		T _J =45°C, t=8.3ms, 60Hz, Sine	94612	A ² s
P _D	Power Dissipation		2080	W
T _J	Junction Temperature		-40 to +150	°C
T _{STG}	Storage Temperature Range		-40 to +125	°C
Torque	Module-to-Sink	Recommended (M6)	3~4.7	N·m
Torque	Module Terminal	Recommended (M6)	3~4.7	N·m
R _{θJC}	Thermal Resistance	Junction-to-Case, Per Diode	0.06	°C /W
Weight			95	g

ELECTRICAL CHARACTERISTICS

T_C=25°C unless otherwise specified

Symbol	Parameter	Test Conditions	Min.	Typ.	Max.	Unit
I _{RM}	Reverse Leakage Current	V _R =600V	--	--	1	mA
		V _R =600V, T _J =125°C	--	--	20	mA
V _F	Forward Voltage	I _F =200A	--	0.92	--	V
		I _F =200A, T _J =125°C	--	0.85	--	V
t _{rr}	Reverse Recovery Time	I _F =1A, V _R =30V, di _F /dt=-200A/μs	--	70	--	ns
t _{rr}	Reverse Recovery Time	V _R =100V, I _F =400A	--	125	--	ns
I _{RRM}	Max. Reverse Recovery Current		di _F /dt=-200A/μs, T _J =25°C	--	14	--
t _{rr}	Reverse Recovery Time	V _R =100V, I _F =400A	--	260	--	ns
I _{RRM}	Max. Reverse Recovery Current		di _F /dt=-200A/μs, T _J =125°C	--	25	--

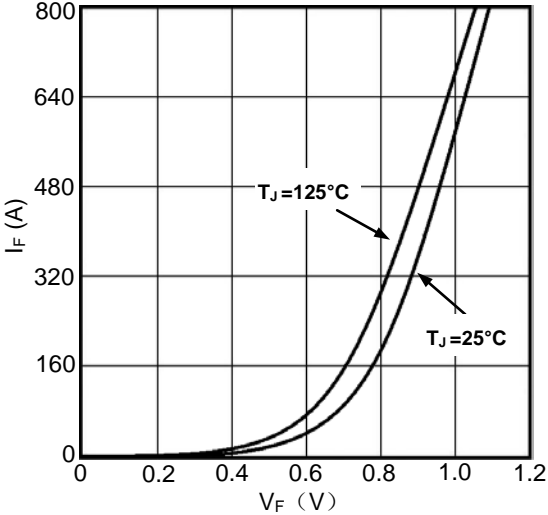

Figure1. Forward Voltage Drop vs Forward Current

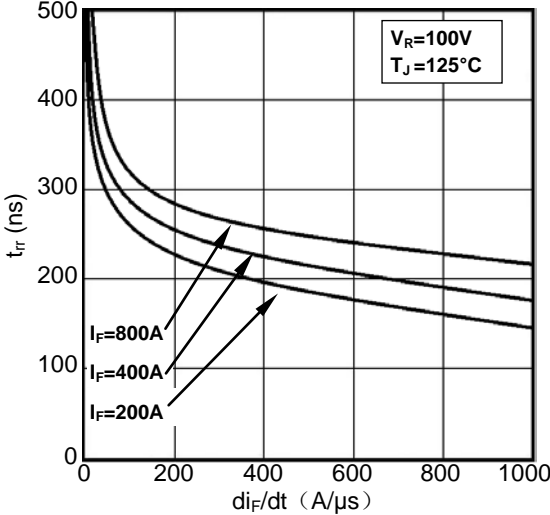

Figure2. Reverse Recovery Time vs di_F/dt

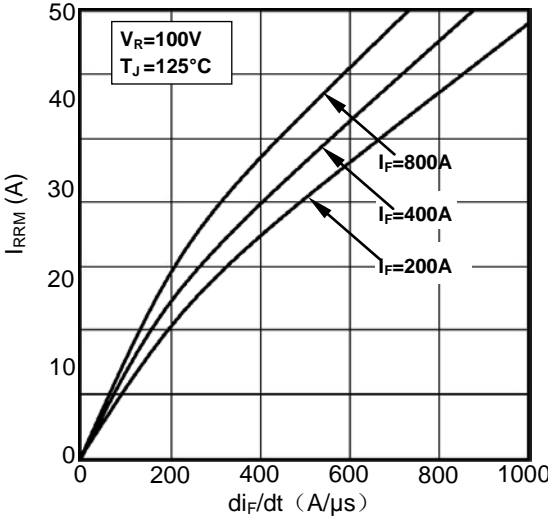

Figure3. Reverse Recovery Current vs di_F/dt

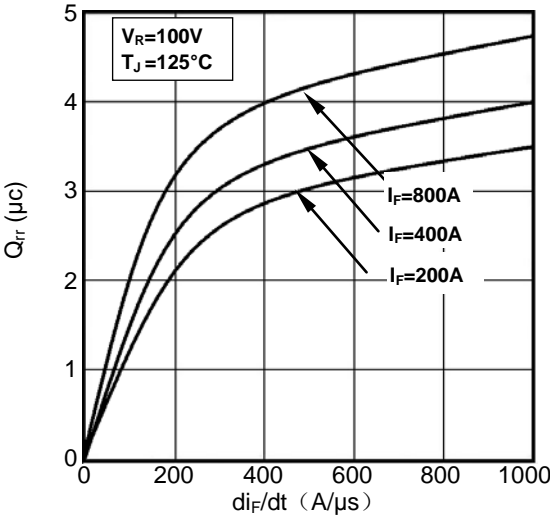

Figure4. Reverse Recovery Charge vs di_F/dt

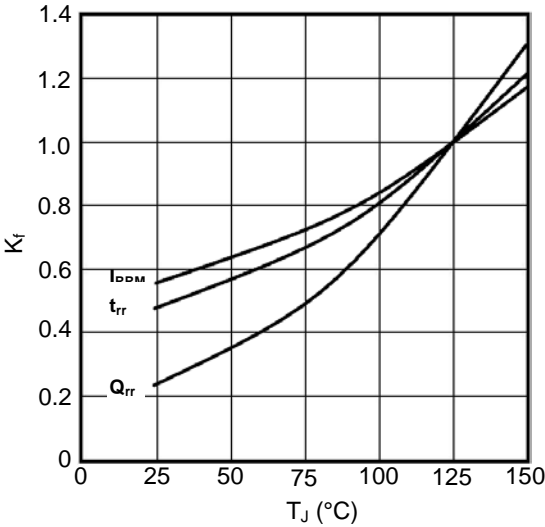

Figure5. Dynamic Parameters vs Junction Temperature

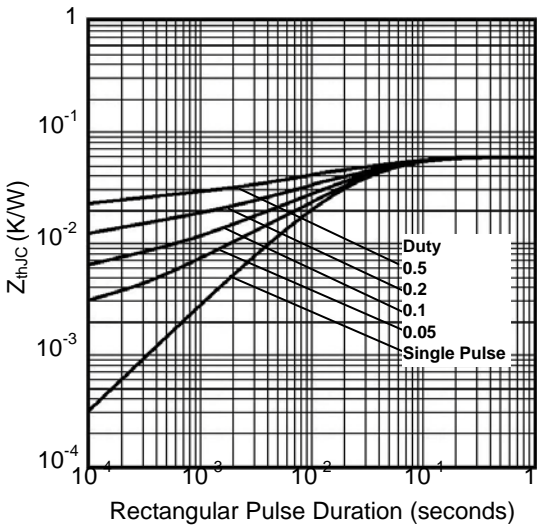
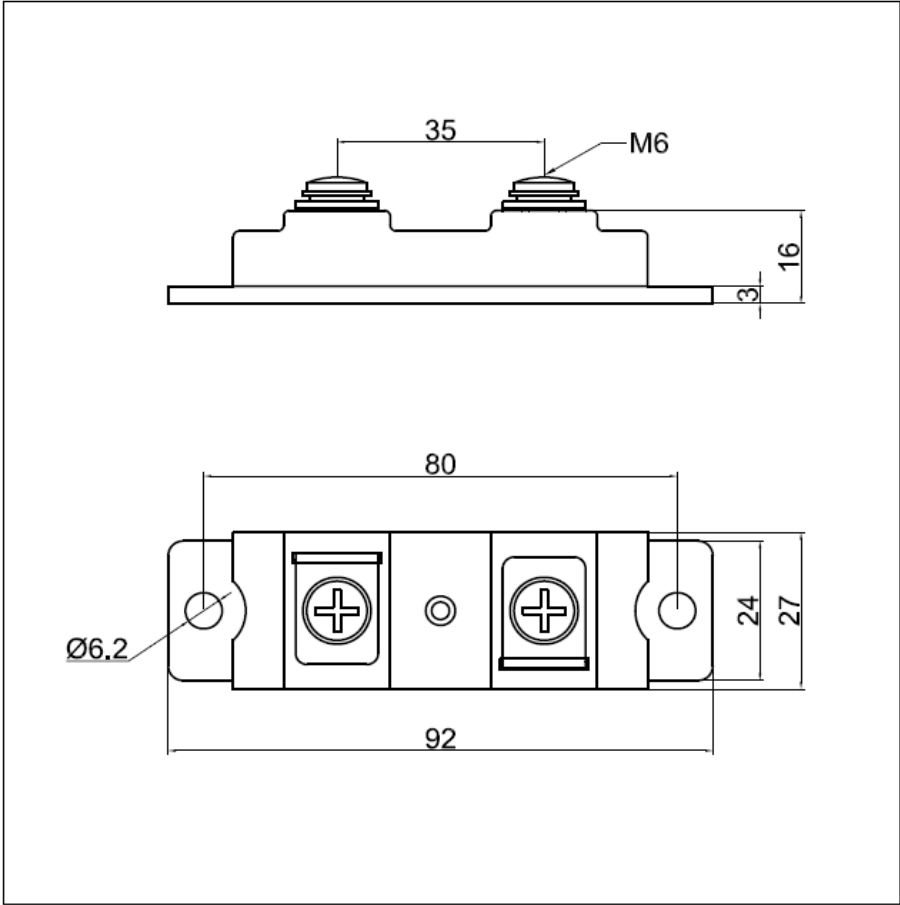

Figure6. Transient Thermal Impedance



Dimensions (mm)
Figure7. Package Outline