

## PRODUCT FEATURES

- IGBT chip in trench FS-technology
- Low switching losses
- $V_{CE(sat)}$  with positive temperature coefficient
- Fast switching and short tail current
- Free wheeling diodes with fast and soft reverse recovery

## APPLICATIONS

- Welding Machine
- Power Supplies
- Others

## IGBT-inverter

### ABSOLUTE MAXIMUM RATINGS

$T_C = 25^\circ\text{C}$  unless otherwise specified

Symbol	Parameter/Test Conditions		Values	Unit
$V_{CES}$	Collector Emitter Voltage	$T_J = 25^\circ\text{C}$	1200	V
$V_{GES}$	Gate Emitter Voltage		$\pm 20$	
$I_C$	DC Collector Current	$T_C = 25^\circ\text{C}$	100	A
		$T_C = 80^\circ\text{C}$	75	
$I_{CM}$	Repetitive Peak Collector Current	$t_p = 1\text{ms}$	150	
$P_{tot}$	Power Dissipation Per IGBT		410	W

## Diode-inverter

### ABSOLUTE MAXIMUM RATINGS

$T_C = 25^\circ\text{C}$  unless otherwise specified

Symbol	Parameter/Test Conditions		Values	Unit
$V_{RRM}$	Repetitive Reverse Voltage	$T_J = 25^\circ\text{C}$	1200	V
$I_{F(AV)}$	Average Forward Current	$T_C = 25^\circ\text{C}$	35	A
$I_{FRM}$	Repetitive Peak Forward Current	$t_p = 1\text{ms}$	70	
$i^2t$		$T_J = 125^\circ\text{C}$ , $t = 10\text{ms}$ , $V_R = 0\text{V}$	300	$\text{A}^2\text{S}$

**IGBT-inverter**  
**ELECTRICAL CHARACTERISTICS**
 $T_C = 25^\circ\text{C}$  unless otherwise specified

Symbol	Parameter/Test Conditions		Min.	Typ.	Max.	Unit
$V_{GE(th)}$	Gate Emitter Threshold Voltage	$V_{CE}=V_{GE}, I_C=3\text{mA}$	5.0	5.8	6.5	V
$V_{CE(sat)}$	Collector Emitter Saturation Voltage	$I_C=75\text{A}, V_{GE}=15\text{V}, T_J=25^\circ\text{C}$		2.2	2.5	
		$I_C=75\text{A}, V_{GE}=15\text{V}, T_J=125^\circ\text{C}$		2.5		
$I_{CES}$	Collector Leakage Current	$V_{CE}=1200\text{V}, V_{GE}=0\text{V}, T_J=25^\circ\text{C}$			100	$\mu\text{A}$
		$V_{CE}=1200\text{V}, V_{GE}=0\text{V}, T_J=125^\circ\text{C}$			1	$\text{mA}$
$I_{GES}$	Gate Leakage Current	$V_{CE}=0\text{V}, V_{GE}=\pm 15\text{V}, T_J=125^\circ\text{C}$	-400		400	$\text{nA}$
$R_{gint}$	Integrated Gate Resistor			0		$\Omega$
$Q_g$	Gate Charge	$V_{CE}=600\text{V}, I_C=75\text{A}, V_{GE}=15\text{V}$		0.4		$\mu\text{C}$
$C_{ies}$	Input Capacitance	$V_{CE}=25\text{V}, V_{GE}=0\text{V}, f=1\text{MHz}$		9.4		$\text{nF}$
$C_{res}$	Reverse Transfer Capacitance				160	
$t_{d(on)}$	Turn on Delay Time	$V_{CC}=600\text{V}, I_C=75\text{A}$ $R_G=15\Omega,$ $V_{GE}=\pm 15\text{V},$ Inductive Load	$T_J=25^\circ\text{C}$		80	$\text{ns}$
			$T_J=125^\circ\text{C}$		90	$\text{ns}$
$t_r$	Rise Time		$T_J=25^\circ\text{C}$		45	$\text{ns}$
			$T_J=125^\circ\text{C}$		50	$\text{ns}$
$t_{d(off)}$	Turn off Delay Time	$V_{CC}=600\text{V}, I_C=75\text{A}$ $R_G=15\Omega,$ $V_{GE}=\pm 15\text{V},$ Inductive Load	$T_J=25^\circ\text{C}$		360	$\text{ns}$
			$T_J=125^\circ\text{C}$		400	$\text{ns}$
$t_f$	Fall Time		$T_J=25^\circ\text{C}$		50	$\text{ns}$
			$T_J=125^\circ\text{C}$		60	$\text{ns}$
$E_{on}$	Turn on Energy	$V_{CC}=600\text{V}, I_C=75\text{A}$ $R_G=15\Omega,$ $V_{GE}=\pm 15\text{V},$ Inductive Load	$T_J=25^\circ\text{C}$		5	$\text{mJ}$
			$T_J=125^\circ\text{C}$		8	$\text{mJ}$
$E_{off}$	Turn off Energy		$T_J=25^\circ\text{C}$		3.2	$\text{mJ}$
			$T_J=125^\circ\text{C}$		3.8	$\text{mJ}$
$I_{sc}$	Short Circuit Current	$t_{psc} \leq 10\mu\text{s}, V_{GE}=15\text{V}$ $T_J=125^\circ\text{C}, V_{CC}=600\text{V}$		300		A
$R_{thJC}$	Junction to Case Thermal Resistance ( Per IGBT )				0.3	$\text{K/W}$

**Diode-inverter**  
**ELECTRICAL CHARACTERISTICS**
 $T_C = 25^\circ\text{C}$  unless otherwise specified

Symbol	Parameter/Test Conditions		Min.	Typ.	Max.	Unit
$V_F$	Forward Voltage	$I_F=35\text{A}, V_{GE}=0\text{V}, T_J=25^\circ\text{C}$		1.65	2.15	V
		$I_F=35\text{A}, V_{GE}=0\text{V}, T_J=125^\circ\text{C}$		1.65		
$t_{rr}$	Reverse Recovery Time	$I_F=35\text{A}, V_R=600\text{V}$		180		$\text{ns}$
$I_{RRM}$	Max. Reverse Recovery Current	$di_F/dt=-1100\text{A}/\mu\text{s}$		60		A
$Q_{RR}$	Reverse Recovery Charge	$T_J=125^\circ\text{C}$		7.2		$\mu\text{C}$
$E_{rec}$	Reverse Recovery Energy				2.9	
$R_{thJCD}$	Junction to Case Thermal Resistance ( Per Diode )				0.9	$\text{K/W}$

## MODULE CHARACTERISTICS

$T_C = 25^\circ\text{C}$  unless otherwise specified

Symbol	Parameter/Test Conditions		Values	Unit
$T_{Jmax}$	Max. Junction Temperature		150	°C
$T_{Jop}$	Operating Temperature		-40~125	
$T_{stg}$	Storage Temperature		-40~125	
$V_{isol}$	Isolation Breakdown Voltage	AC, 50Hz(R.M.S), t=1minute	3000	V
Torque	to heatsink	Recommended (M6)	3~5	Nm
	to terminal	Recommended (M5)	2.5~5	Nm
Weight			220	g

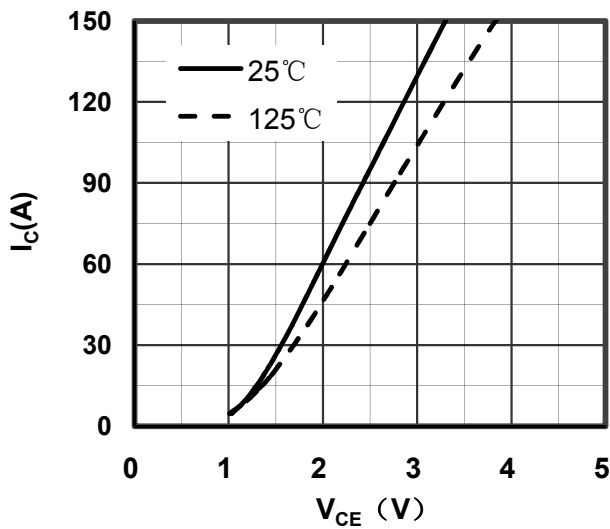

Figure 1. Typical Output Characteristics IGBT-inverter

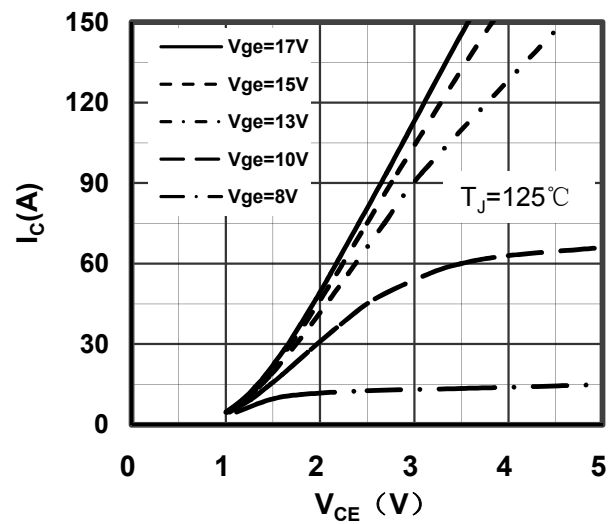

Figure 2. Typical Output Characteristics IGBT-inverter

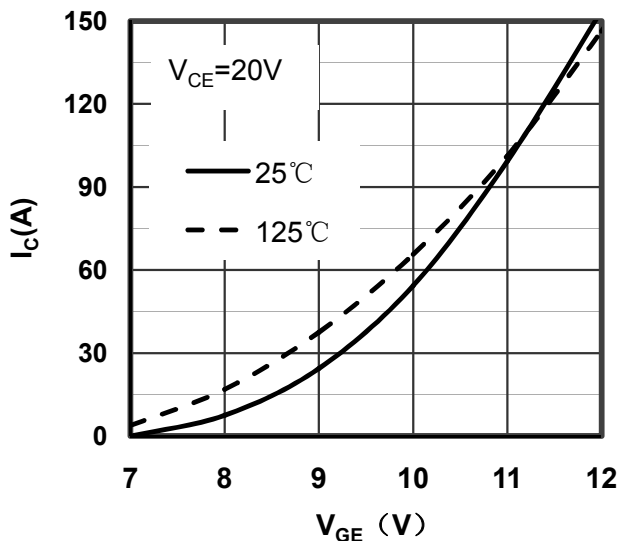

Figure 3. Typical Transfer characteristics IGBT-inverter

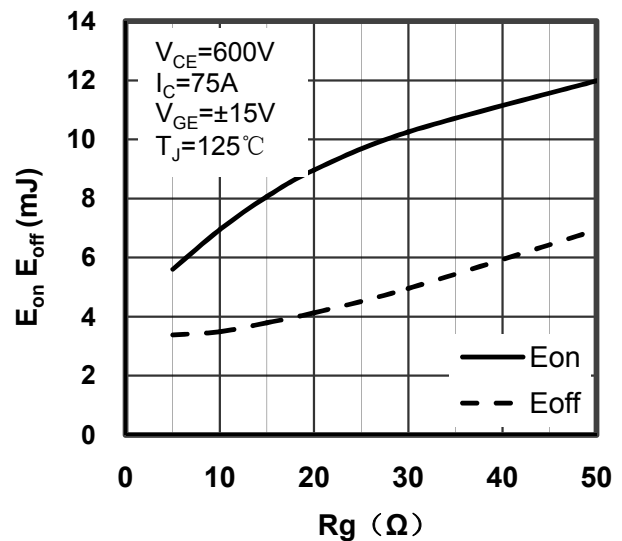

Figure 4. Switching Energy vs Gate Resistor IGBT-inverter

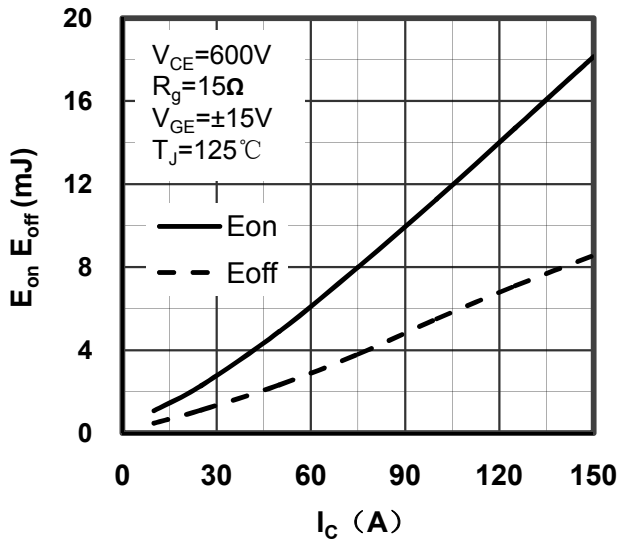

Figure 5. Switching Energy vs Collector Current IGBT-inverter

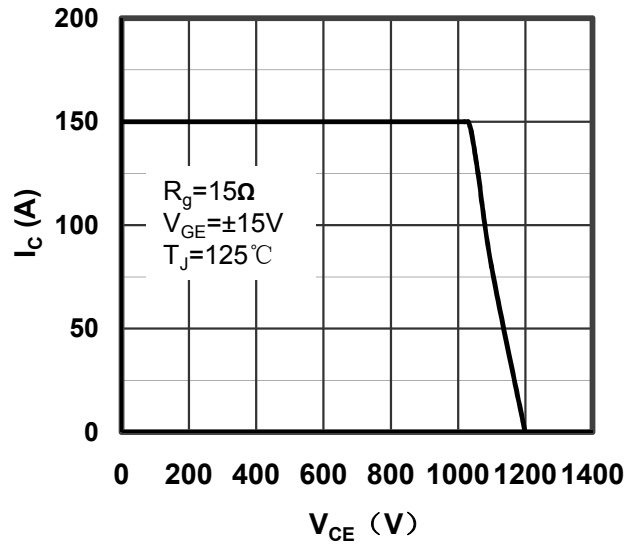

Figure 6. Reverse Biased Safe Operating Area IGBT-inverter

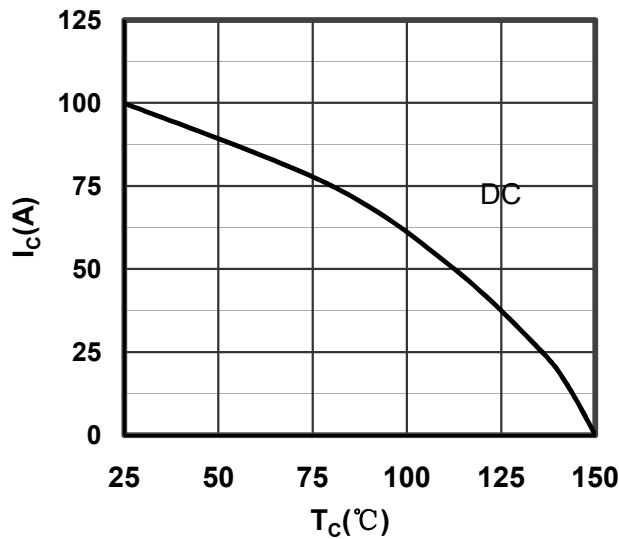

Figure 7. Collector Current vs Case temperature IGBT-inverter

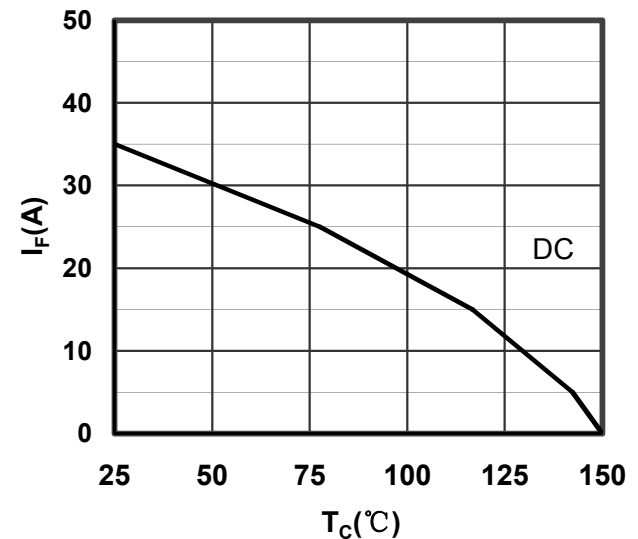

Figure 8. Forward current vs Case temperature Diode-inverter

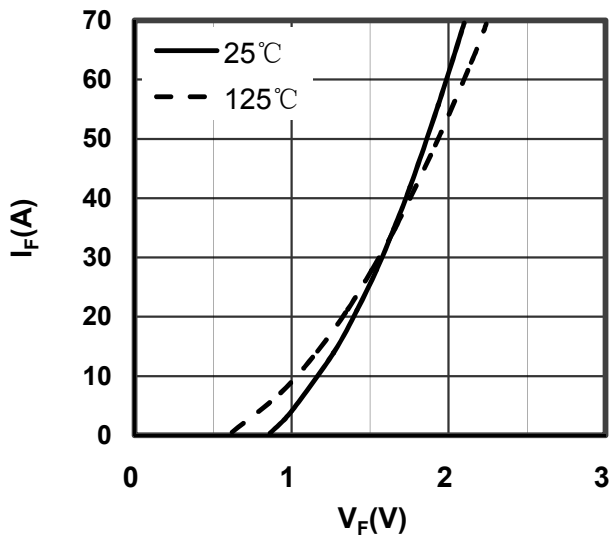

Figure 9. Diode Forward Characteristics Diode-inverter

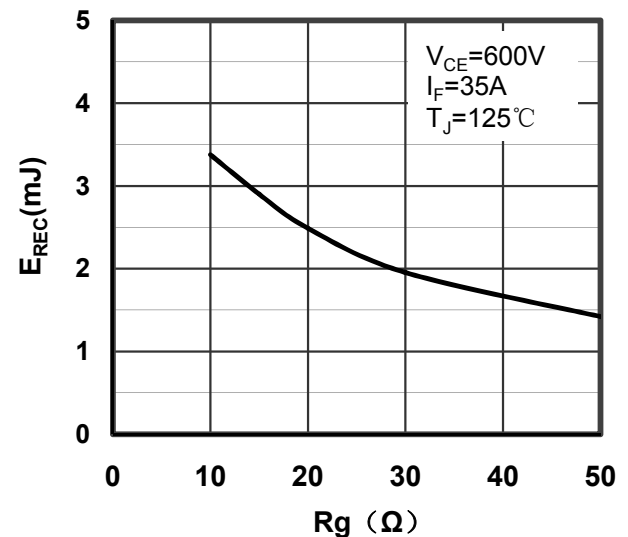

Figure 10. Switching Energy vs Gate Resistor Diode-inverter

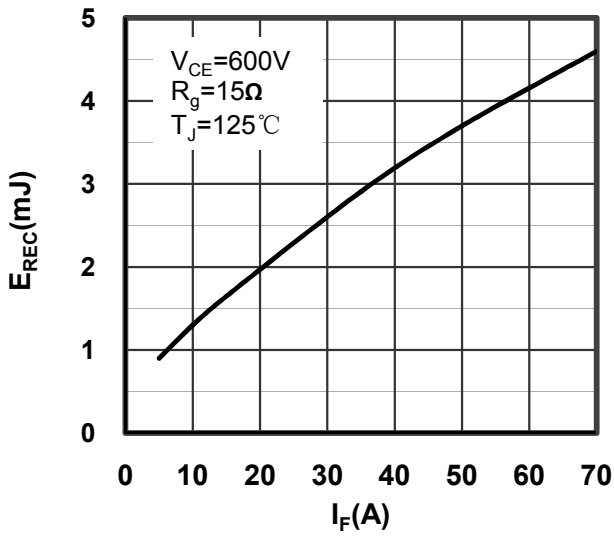

Figure 11. Switching Energy vs Forward Current Diode-inverter

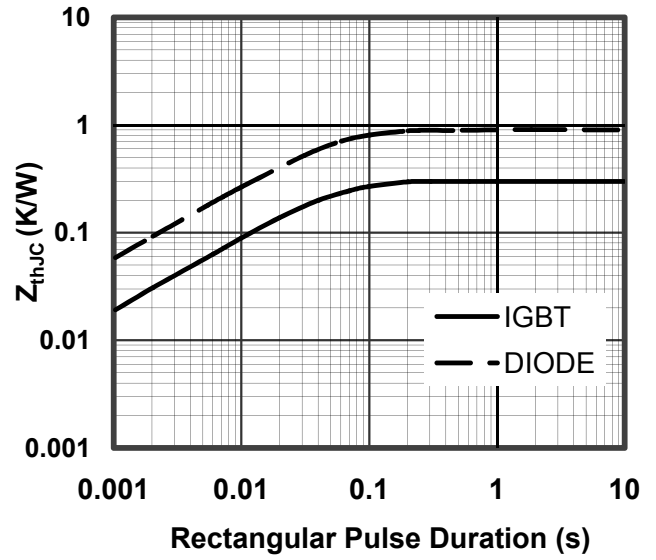

Figure 12. Transient Thermal Impedance of Diode and IGBT-inverter

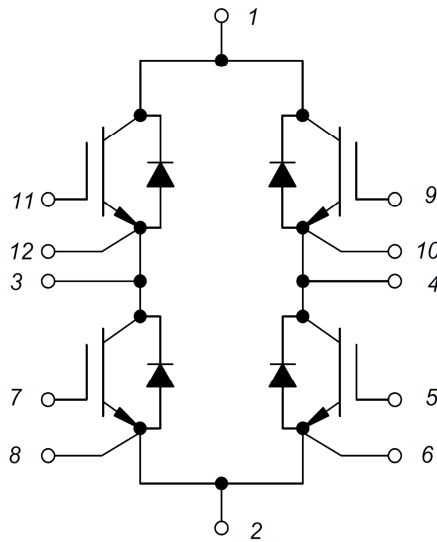
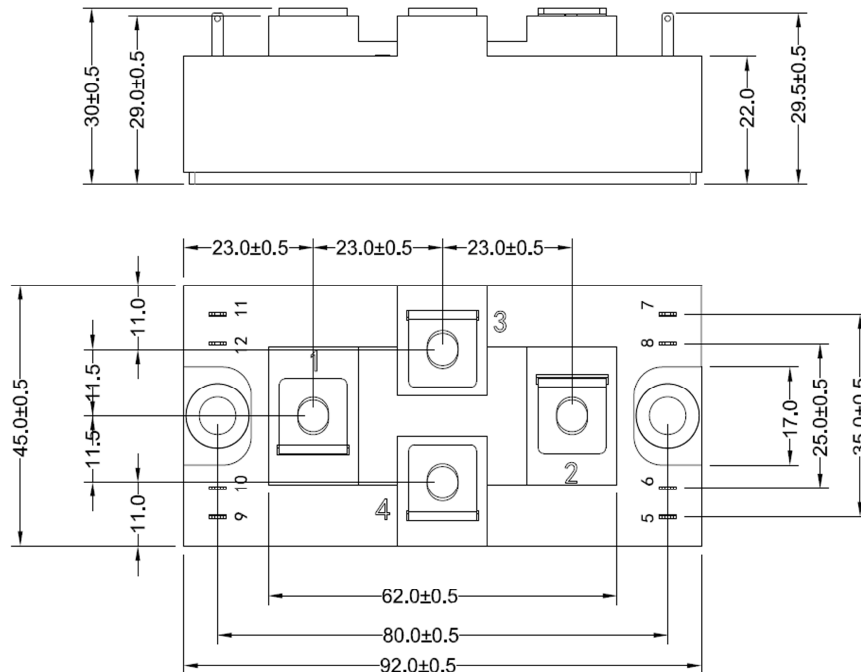

Figure 13. Circuit Diagram



Dimensions in (mm)  
Figure 14. Package Outline