

N-Channel Super Junction MOSFET

Features

- Drain-Source voltage: $V_{DS}=700V$ (@ $T_J=150^\circ C$)
- Low drain-source On resistance: $R_{DS(on)}=0.38\Omega$ (Max.)
- Ultra low gate charge: $Q_g=20nC$ (Typ.)
- RoHS compliant device
- 100% avalanche tested

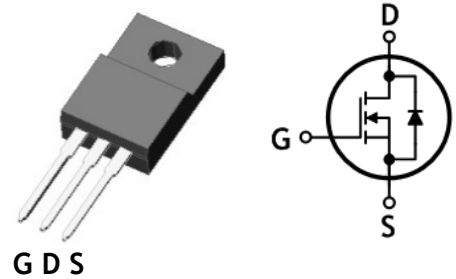

Ordering Information

Part Number	Marking	Package
SJMN380R65AF	N380R65	TO-220F-3L

TO-220F-3L

Marking Information

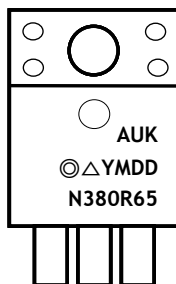

Column 1: Manufacturer
 Column 2: Production Information
 e.g.) ©△YMDD
 -. ©△: Factory Management Code
 -. YMDD: Date Code (Year, Month, Daily)
 Column 3: Device Code

Absolute maximum ratings ($T_C=25^\circ C$ unless otherwise noted)

Characteristic	Symbol	Rating	Unit	
Drain-source voltage	V_{DSS}	650	V	
Gate-source voltage	V_{GSS}	± 30	V	
Drain current (DC) (Note 1)	I_D	$T_C=25^\circ C$	11	A
		$T_C=100^\circ C$	7	A
Drain current (Pulsed) (Note 1)	I_{DM}	44	A	
Single pulsed avalanche energy (Note 2)	E_{AS}	135	mJ	
Repetitive avalanche current (Note 1)	I_{AR}	5	A	
Repetitive avalanche energy (Note 1)	E_{AR}	63.2	mJ	
Power dissipation	P_D	32	W	
Diode dv/dt ruggedness (Note 3)	dv/dt	15	V/ns	
MOSFET dv/dt ruggedness (Note 4)	dv/dt	50	V/ns	
Junction temperature	T_J	150	$^\circ C$	
Storage temperature range	T_{stg}	-55-150	$^\circ C$	

Thermal Characteristics

Characteristic	Symbol	Rating	Unit
Thermal resistance, junction to case	$R_{th(j-c)}$	Max. 3.9	°C/W
Thermal resistance, junction to ambient	$R_{th(j-a)}$	Max. 62.5	

Electrical Characteristics ($T_C=25^\circ\text{C}$ unless otherwise noted)

Characteristic	Symbol	Test Condition	Min.	Typ.	Max.	Unit
Drain-source breakdown voltage	BV_{DSS}	$I_D=250\mu\text{A}$, $V_{GS}=0$	650	-	-	V
Gate threshold voltage	$V_{GS(th)}$	$I_D=250\mu\text{A}$, $V_{DS}=V_{GS}$	2	3	4	V
Drain-source cut-off current	I_{DSS}	$V_{DS}=650\text{V}$, $V_{GS}=0\text{V}$	-	-	1	μA
		$V_{DS}=650\text{V}$, $T_J=125^\circ\text{C}$	-	-	100	μA
Gate leakage current	I_{GSS}	$V_{DS}=0\text{V}$, $V_{GS}=\pm 30\text{V}$	-	-	± 100	nA
Drain-source on-resistance	$R_{DS(ON)}$	$V_{GS}=10\text{V}$, $I_D=5.5\text{A}$	-	0.31	0.38	Ω
Internal gate resistance	R_g	$f=1\text{MHz}$, Open drain	-	21	28	Ω
Input capacitance	C_{iss}	$V_{DS}=25\text{V}$, $V_{GS}=0\text{V}$, $f=1\text{MHz}$	629	787	945	pF
Output capacitance	C_{oss}		344	431	518	
Reverse transfer capacitance	C_{rss}		19	24	29	
Turn-on delay time (Note 3)	$t_{d(on)}$	$V_{DS}=350\text{V}$, $I_D=11\text{A}$, $R_G=25\Omega$	-	17	25	ns
Rise time (Note 3)	t_r		-	14	24	
Turn-off delay time (Note 3)	$t_{d(off)}$		-	40	55	
Fall time (Note 3)	t_f		-	5	8	
Total gate charge (Note 4)	Q_g	$V_{DS}=400\text{V}$, $V_{GS}=10\text{V}$, $I_D=7\text{A}$	-	20	25	nC
Gate-source charge (Note 4)	Q_{gs}		-	6.5	10	
Gate-drain charge (Note 4)	Q_{gd}		-	5	10	

Source-Drain Diode Ratings and Characteristics ($T_C=25^\circ\text{C}$ unless otherwise noted)

Characteristic	Symbol	Test Condition	Min.	Typ.	Max.	Unit
Source current (DC)	I_S	Integral reverse diode in the MOSFET	-	-	11	A
Source current (Pulsed)	I_{SM}		-	-	44	A
Forward voltage	V_{SD}	$V_{GS}=0\text{V}$, $I_S=11\text{A}$	-	-	1.2	V
Reverse recovery time (Note 3,4)	t_{rr}	$I_S=11\text{A}$, $V_{GS}=0\text{V}$, $dI_S/dt=100\text{A}/\mu\text{s}$	-	326	450	ns
Reverse recovery charge (Note 3,4)	Q_{rr}		-	2.8	4.5	μC

Note:

1. Calculated continuous current based on maximum allowable junction temperature
2. $L=10\text{mH}$, $I_{AS}=5\text{A}$, $V_{DD}=50\text{V}$, Starting $T_J=25^\circ\text{C}$
3. Guaranteed by design, not subject to production testing
4. Pulse test: Pulse width $\leq 300\mu\text{s}$, Duty cycle $\leq 2\%$

Typical Electrical Characteristics Curves

Fig. 1 Typical Output Characteristics

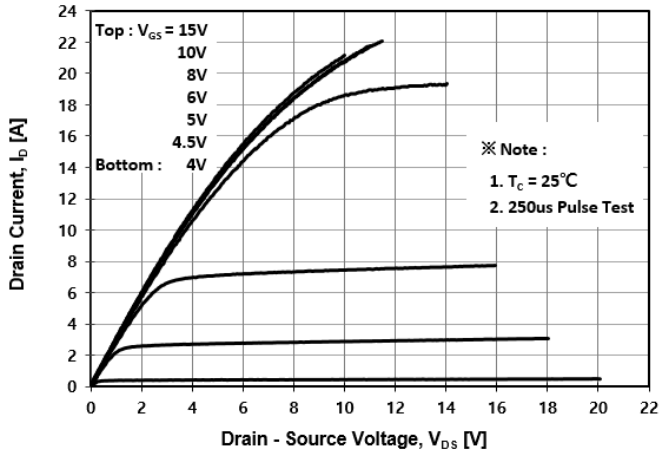

Fig. 2 Typical Transfer Characteristics

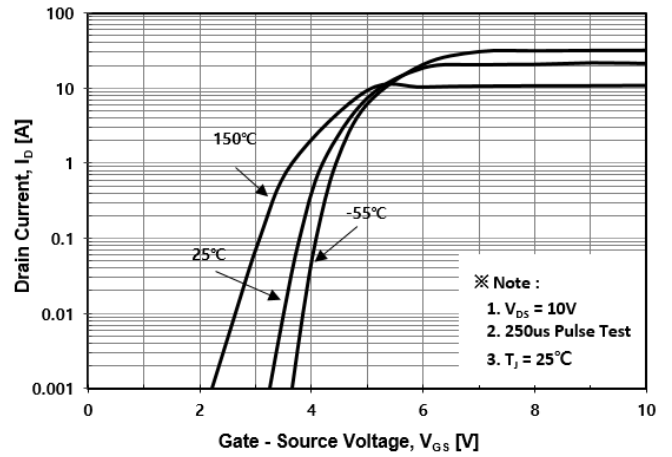

Fig.3 On-Resistance Variation with Drain Current and Gate Voltage

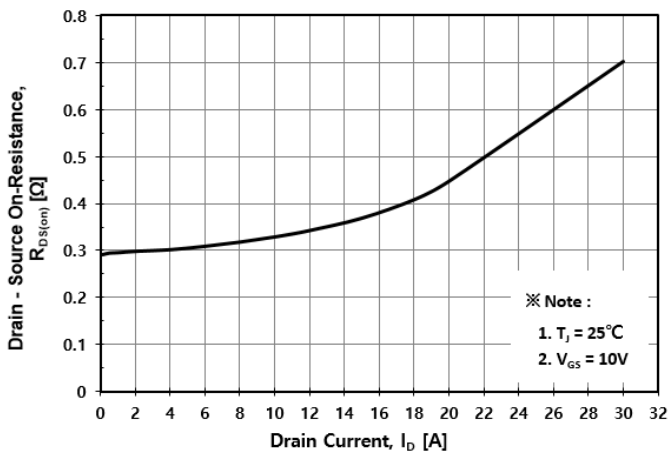

Fig. 4 Body Diode Forward Voltage Variation with Source Current

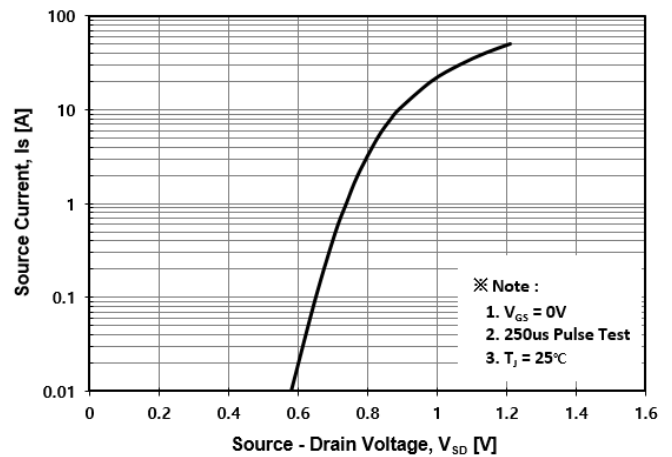

Fig. 5 Typical Capacitance Characteristics

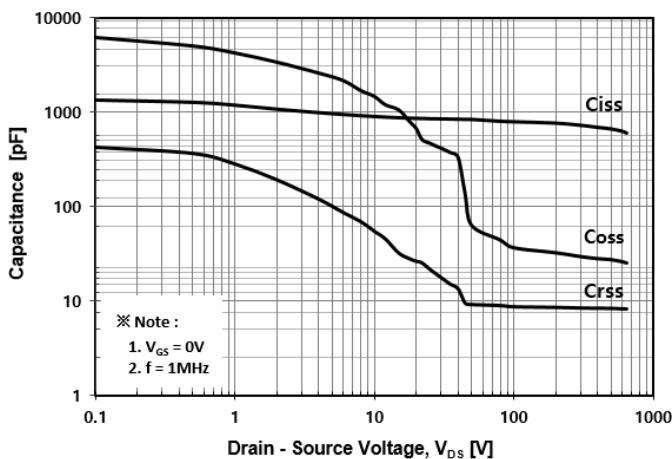

Fig. 6 Typical Total Gate Charge Characteristics

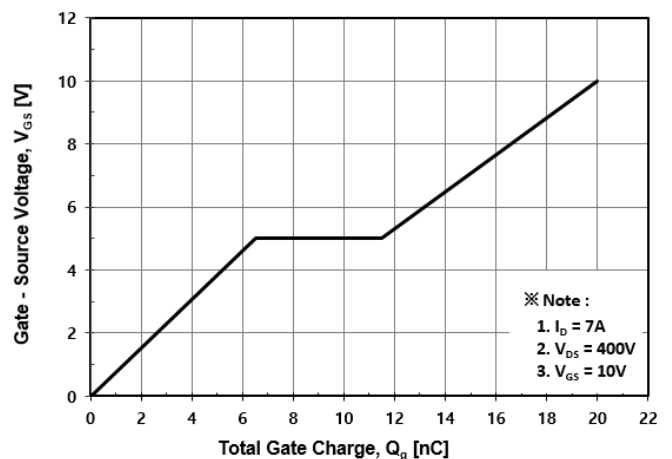

Fig. 7 Breakdown Voltage Variation vs. Temperature

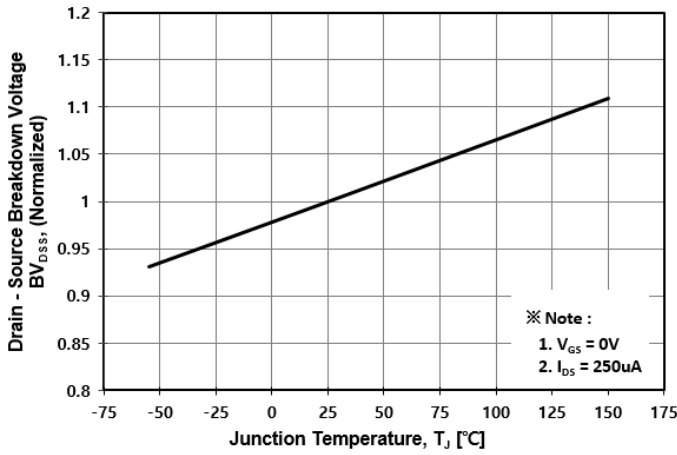

Fig. 8 On-Resistance Variation vs. Temperature

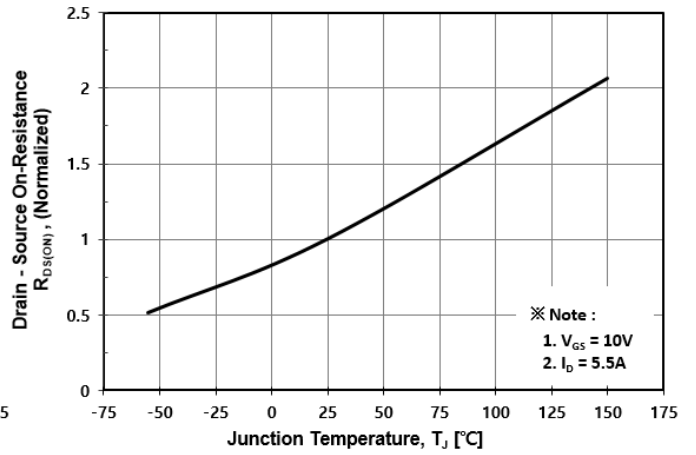

Fig. 9 Maximum Drain Current vs. Case Temperature

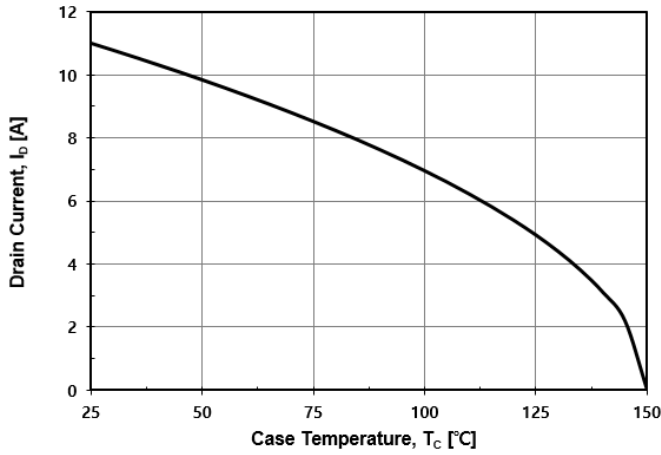

Fig. 10 Maximum Safe Operating Area

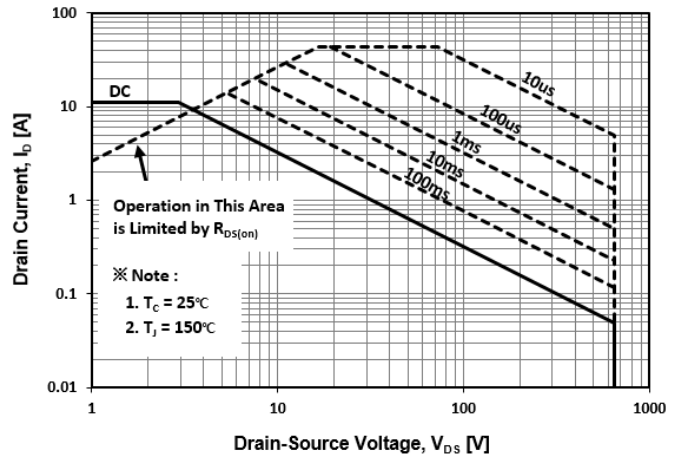

Fig. 11 Transient Thermal Impedance

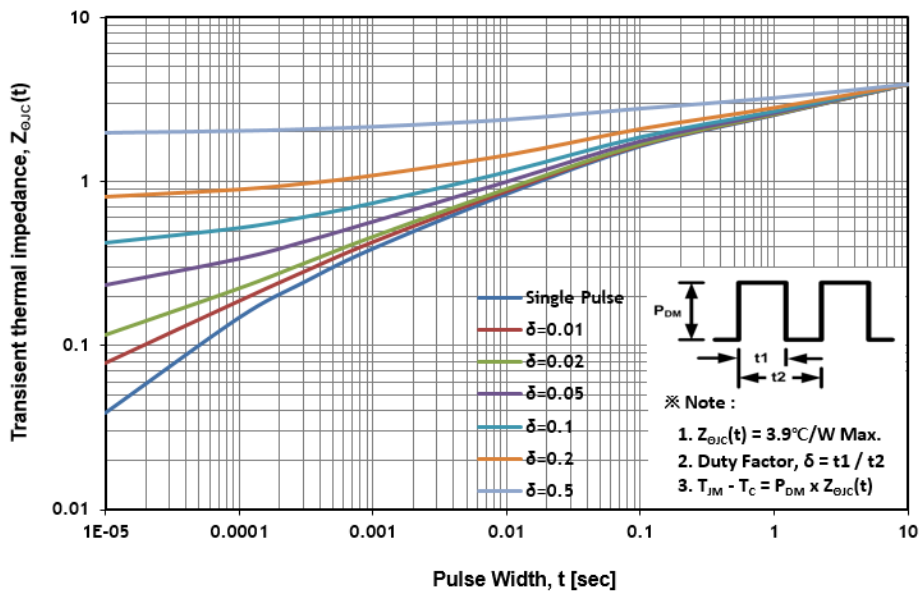

Fig. 12 Gate Charge Test Circuit & Waveform

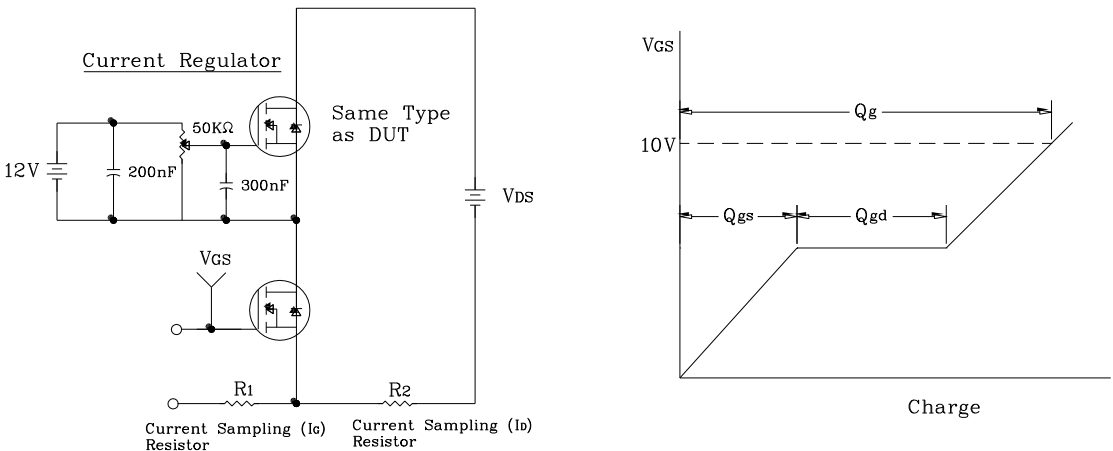

Fig. 13 Resistive Switching Test Circuit & Waveform

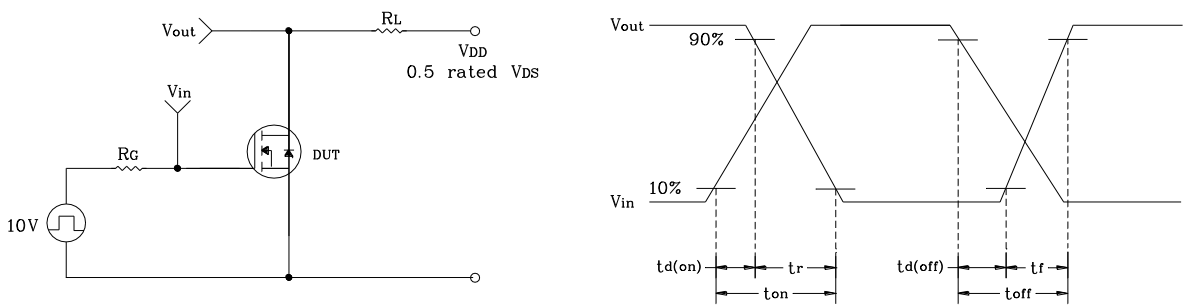
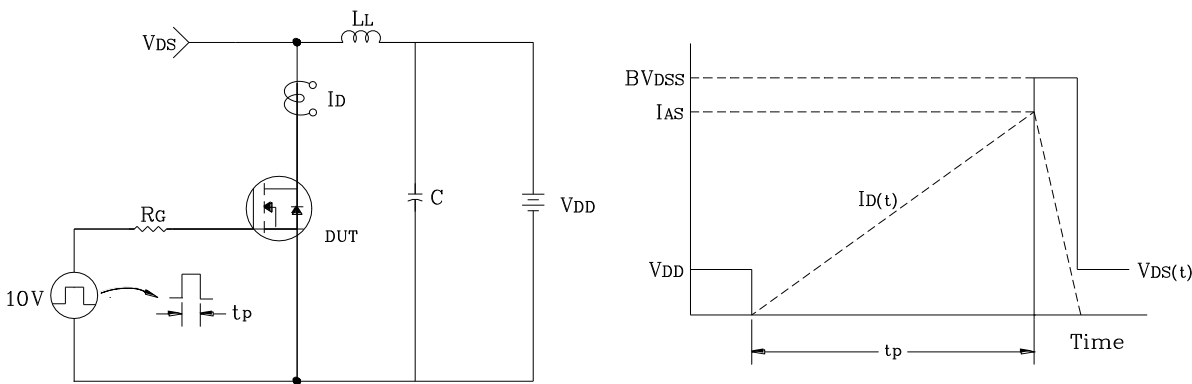
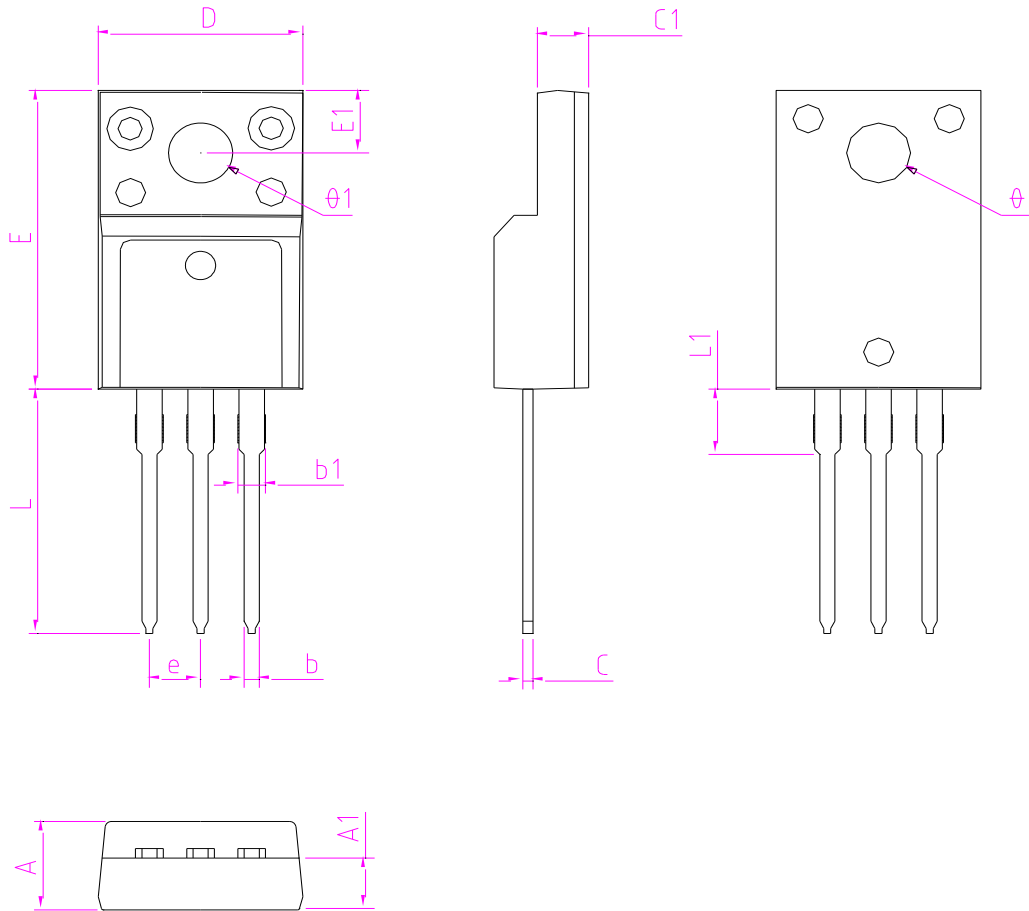

Fig. 14 E_{AS} Test Circuit & Waveform



Package Outline Dimensions



SYMBOL	MILLIMETERS			NOTE
	MINIMUM	NOMINAL	MAXIMUM	
A	4.65	4.70	4.75	
A1	2.71	2.76	2.81	
b	0.70	0.80	0.90	
b1	1.28	1.38	1.43	
C	0.40	0.50	0.60	
C1	2.04	2.54	3.04	
D	10.06	10.16	10.26	
e	2.54 REF			
E	15.77	15.87	15.97	
E1	3.05	3.30	3.55	
L	12.68	12.98	13.28	
L1	3.18 REF			
θ	3.30	3.40	3.50	
θ1	3.08	3.18	3.28	

The AUK Corp. products are intended for the use as components in general electronic equipment (Office and communication equipment, measuring equipment, home appliance, etc.).

Please make sure that you consult with us before you use these AUK Corp. products in equipments which require high quality and / or reliability, and in equipments which could have major impact to the welfare of human life(atomic energy control, airplane, spaceship, transportation, combustion control, all types of safety device, etc.). AUK Corp. cannot accept liability to any damage which may occur in case these AUK Corp. products were used in the mentioned equipments without prior consultation with AUK Corp..

Specifications mentioned in this publication are subject to change without notice.